





# PICO-STYLE QUICK DISCONNECT CABLES

Diameter		M8 pico-style	M8 pico-style
Feature		<ul style="list-style-type: none"> <li>● Female pico-style</li> <li>● Screw locking with (auto) securing safety nut</li> <li>● With moulded cable</li> </ul>	<ul style="list-style-type: none"> <li>● Female pico-style</li> <li>● Right-angle style</li> <li>● Screw locking with (auto) securing safety nut</li> <li>● With moulded cable</li> </ul>
Picture			
Application Class		HNE acc.to DIN 40040 (-25°C/+90°C/≥75%rF)	HNE acc.to DIN 40040 (-25°C/+90°C/≥75%rF)
Moulded Body		TPU, self-extinguishing	TPU, self-extinguishing
Nominal Power		4A	4A
Nominal Voltage		60VAC/75VDC	60VAC/75VDC
Contact		CuZn,pre-nickel and 0.8microns gold-plated	CuZn,pre-nickel and 0.8microns gold-plated
O-Ring		Viton	Viton
Body		TPU,self-extinguishing	TPU,self-extinguishing
Securing Safety nut		Nickel plated brass	Nickel plated brass
Protection		IP 67	IP 67
Contact Resistance		≤5mΩ	≤5mΩ
Insulation Group		C acc.to VDE 0110	C acc.to VDE 0110
Test Voltage		1.5 KV eff./ 60 s.	1.5 KV eff./ 60 s.
Insulation Resistance		>10 <sup>9</sup> Ω	>10 <sup>9</sup> Ω
Part-No		<b>P-FS3WLV012</b>	<b>P-FA3WLV012</b>
Poles		<b>3</b>	<b>3</b>
Face View female			
Color Code		1=brown 3=blue 4=black	1=brown 3=blue 4=black
Conductors	Gage	0.34mm <sup>2</sup>	0.34mm <sup>2</sup>
	Stranding	42xφ0.10	42xφ0.10
Outer Jacket	φmm	5.0	5.0
	Material	PVC	PVC
Dimensions (unit: mm)			
Remark		Standard Length: 2.0 m, 3.0 m, 7.5 m, 10.0 m. Other cable length or cablespecifications on request.	Standard Length: 2.0 m, 3.0 m, 7.5 m, 10.0 m. Other cable length or cablespecifications on request.

# PICO-STYLE QUICK DISCONNECT CABLES

## M8 pico-style

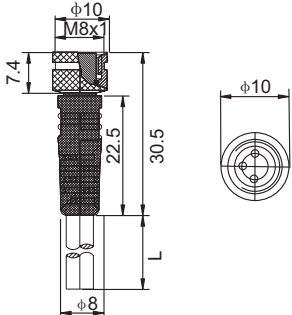
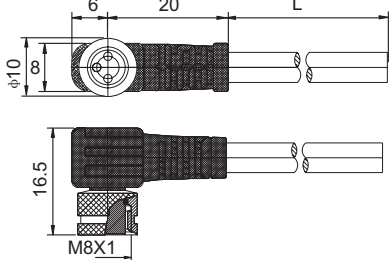
- Female pico-style
- Screw locking with (auto) securing safety nut
- With moulded cable



HNE acc.to DIN 40040 (-25°C/+90°C/≥75%rF)  
 TPU, self-extinguishing  
 4A  
 60VAC/75VDC  
 CuZn, pre-nickel and 0.8microns gold-plated  
 Viton  
 TPU, self-extinguishing  
 Nickel plated brass  
 IP 67  
 $\leq 5m\Omega$   
 C acc.to VDE 0110  
 1.5 KV eff./ 60 s.  
 $>10^9 \Omega$

## P-FS4WLV022

4



1=brown 2=white 3=blue 4=black

0.25mm<sup>2</sup>

32xφ0.10

5.0

PVC

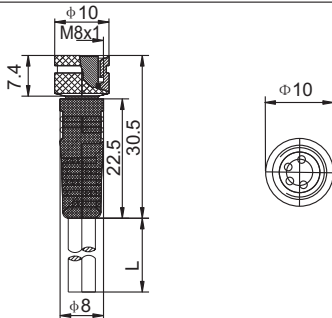

Standard Length: 2.0 m, 3.0 m, 7.5 m, 10.0 m. Other cable length or cablespecifications on request.

## M8 pico-style

- Female pico-style
- Right-angle style
- Screw locking with (auto) securing safety nut
- With moulded cable



HNE acc.to DIN 40040 (-25°C/+90°C/≥75%rF)  
 TPU, self-extinguishing  
 4A  
 60VAC/75VDC  
 CuZn, pre-nickel and 0.8microns gold-plated  
 Viton  
 TPU, self-extinguishing  
 Nickel plated brass  
 IP 67  
 $\leq 5m\Omega$   
 C acc.to VDE 0110  
 1.5 KV eff./ 60 s.  
 $>10^9 \Omega$

## P-FA4WLV022

4



1=brown 2=white 3=blue 4=black

0.25mm<sup>2</sup>

32xφ0.10



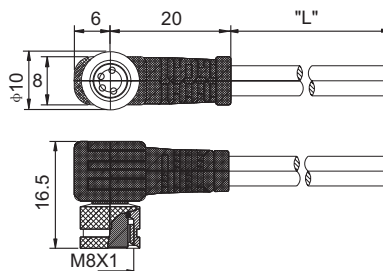

5.0

PVC



Standard Length: 2.0 m, 3.0 m, 7.5 m, 10.0 m. Other cable length or cablespecifications on request.

# EURO-STYLE QUICK DISCONNECT RECEPTACLES

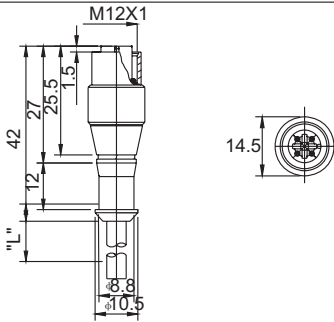
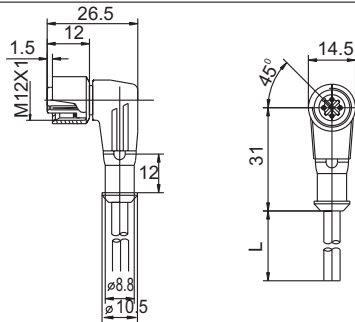
Diameter		M12 Euro-style			M12 Euro-style		
Feature		<ul style="list-style-type: none"> <li>● Female Euro-style</li> <li>● Screw locking with (auto) securing safety nut</li> <li>● With moulded cable</li> </ul>			<ul style="list-style-type: none"> <li>● Female Euro-style</li> <li>● Right-angle style</li> <li>● Screw locking with (auto) securing safety nut</li> <li>● With moulded cable</li> </ul>		
Picture							
Application Class		HNA acc.to DIN 40040 (-25°C/+90°C/≥100%rF)			HNA acc.to DIN 40040 (-25°C/+90°C/≥100%rF)		
Moulded Body		TPU, self-extinguishing			TPU, self-extinguishing		
Nominal Power		4A(CSA=3A) , 8 poles=1.5A			4A(CSA=3A)		
Nominal Voltage		3+4poles, 250VAC/300VDC 5+8poles, 30VAC/36VDC			3+4poles, 250VAC/300VDC 5poles, 30VAC/36VDC		
Contact		CuSn, brass, pre-nickelated and 0.3 microns gold-plated 8poles=CuZn, pre-nickelated and 0.8 microns gold-plated			CuSn, brass, pre-nickelated and 0.3 microns gold-plated		
O-Ring		Viton			Viton		
Body		TPU, self-extinguishing			TPU, self-extinguishing		
Securing Safety nut		Nickel plated brass			Nickel plated brass		
Protection		IP 68			IP 68		
Contact Resistance		≤ 5 mΩ			≤ 5 mΩ		
Insulation Group		C acc.to VDE 0110			C acc.to VDE 0110		
Test Voltage		3+4poles, 2.0 KV eff./60s. 5+8poles, 1.5 KV eff./60s.			3+4poles, 2.0 KV eff./60s. 5+8poles, 1.5 KV eff./60s.		
Insulation Resistance		>10 <sup>9</sup> Ω			>10 <sup>9</sup> Ω		
Part-No		<b>E-FS4WLV042</b>			<b>E-FA4WLV042</b>		
Poles		4			4		
Face View female							
Color Code		1=brown 2=white 3=blue 4=black			1=brown 2=white 3=blue 4=black		
Conductors	Gage	0.25mm <sup>2</sup>	0.34mm <sup>2</sup>	0.25mm <sup>2</sup>	0.25mm <sup>2</sup>	0.34mm <sup>2</sup>	0.25mm <sup>2</sup>
	Stranding	32xφ0.10	42xφ0.10	32xφ0.10	32xφ0.10	42xφ0.10	32xφ0.10
Outer Jacket	φmm	5.0			5.0		
	Material	PVC	PVC irradiated	PUR / PVC	PVC	PVC irradiated	PUR / PVC
Dimensions (unit: mm)							
Remark		Standard Length: 2.0 m, 5.0 m, 7.5 m, 10.0 m. Other cable Length or cable specifications on request			Standard Length: 2.0 m, 5.0 m, 7.5 m, 10.0 m. Other cable Length or cable specifications on request		

# MICRO-STYLE QUICK DISCONNECT CABLES

## M12 Micro-style

- Female Micro-style
- Screw locking with (auto) securing safety nut
- With moulded cable
- PVC offers good resistance to and chemicals



HNA acc.to DIN 40040 (-25°C/+90°C/≥100%rF)

TPU, self-extinguishing

4A

300VAC

Cuzn, brass, pre-nickeled and 0.3 microns gold-plated  
5poles=Cuzn, pre-nickeled and 0.8 microns gold-plated

Viton

TPU, self-extinguishing

Nickel plated brass

IP 68

≤ 5 mΩ

-

3+4poles, 2.0 KV eff./60s. 5poles, 1.5 KV eff./60s.

>10<sup>9</sup> Ω

## M-FS3WLV052

3



1= black 2= blue 3= brown

0.25mm<sup>2</sup>

26xφ0.13

5.0

PVC

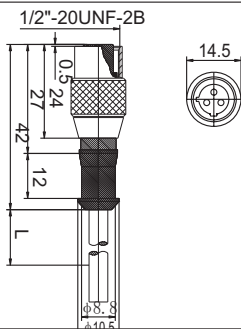

Standard Length: 2.0 m, 5.0 m, 7.5 m, 10.0 m. Other cable Length or cable specifications on request

## M12 Micro-style

- Female Micro-style right-angle style
- Screw locking with (auto) securing safety nut
- With moulded cable
- PVC offers good resistance to and chemicals



HNE acc.to DIN 40040 (-25°C/+90°C/≥100%rF)

TPU, self-extinguishing

4A

300VAC

Cuzn, brass, pre-nickeled and 0.3 microns gold-plated  
5poles=Cuzn, pre-nickeled and 0.8 microns gold-plated

Viton

TPU, self-extinguishing

Nickel plated brass

IP 68

≤ 5 mΩ

-

3+4poles, 2.0 KV eff./60s. 5poles, 1.5 KV eff./60s.

>10<sup>9</sup> Ω

## M-FA3WLV052

3



1= black 2= blue 3= brown

0.25mm<sup>2</sup>

26xφ0.13

5.0

PVC

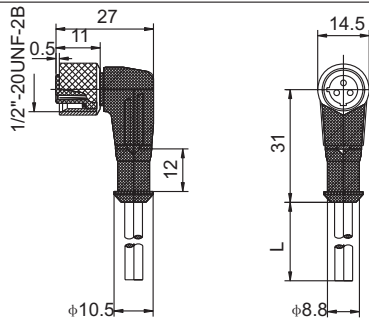

Standard Length: 2.0 m, 5.0 m, 7.5 m, 10.0 m. Other cable Length or cable specifications on request